



**Electrostatic**  
Spraying Systems

# 2018 PHOTOBOOK

---

Complete Confidential Coverage

Revised January 2018

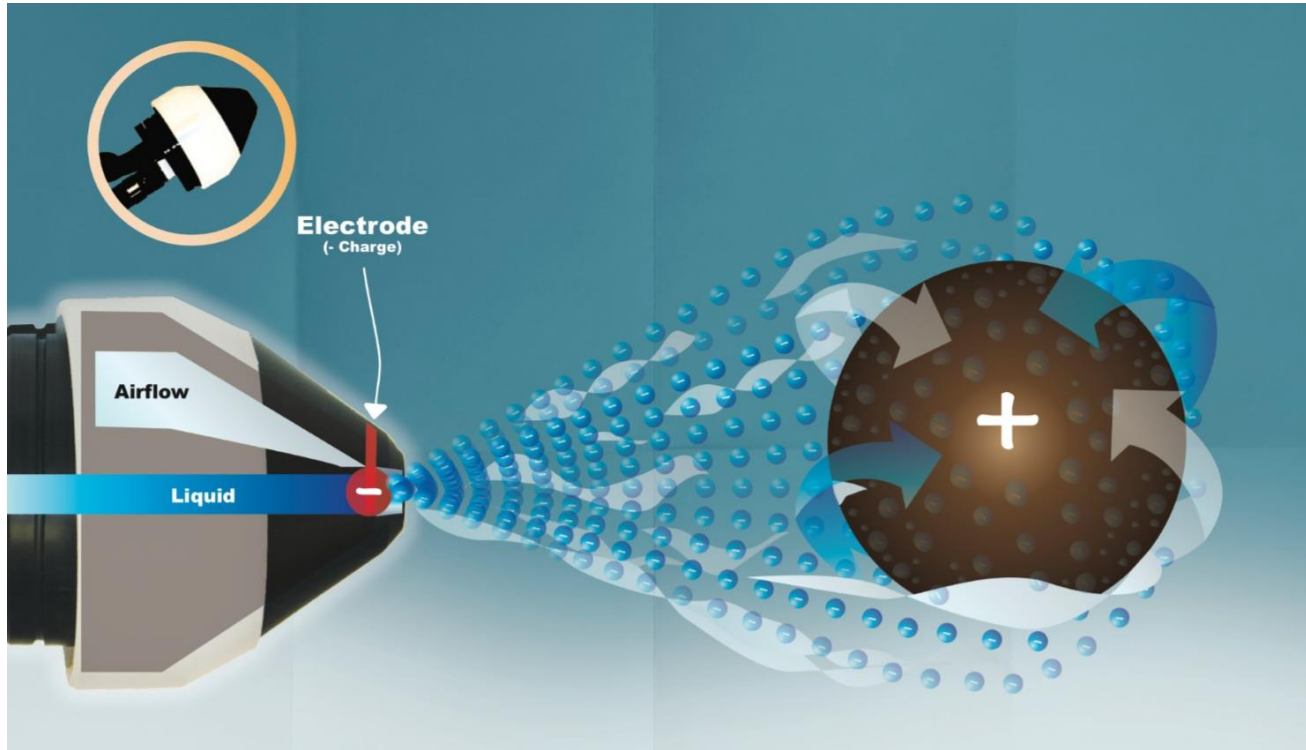

ESS Sprayer vs. Standard Sprayer



Fluorescent Dye Demonstration showing coverage on bananas

# Sanitizing and Industrial Sprayers

Our sanitizing sprayers are extremely adaptable for many different application needs. They are currently being used in hospitals, schools, day care centers, nursing homes, jails, public transportation, office buildings, retail locations, and locker rooms. The sprayers have also been used for human decontamination and biochemical preparedness.



SC-EB



Battery Powered BP2



SC-ET (HD)

# Sanitizing and Industrial Sprayers

Our sanitizing sprayers are extremely adaptable for many different application needs. They are currently being used in hospitals, schools, day care centers, nursing homes, jails, public transportation, office buildings, retail locations, and locker rooms. The sprayers have also been used for human decontamination and biochemical preparedness.



EZmist360



NC2

# Sanitizing and Industrial Sprayers

Our sanitizing sprayers are extremely adaptable for many different application needs. They are currently being used in hospitals, schools, day care centers, nursing homes, jails, public transportation, office buildings, retail locations, and locker rooms. The sprayers have also been used for human decontamination and biochemical preparedness.



XT-3



Touchless Disinfection Cart  
(Basic)



Touchless Disinfection Carts  
(Storage)

# Commercial Sprayers



TRG  
GPS-5



PTO-215



MBP



EPS-5

# Industrial Vehicle Sprayer





# Poultry House Sprayer

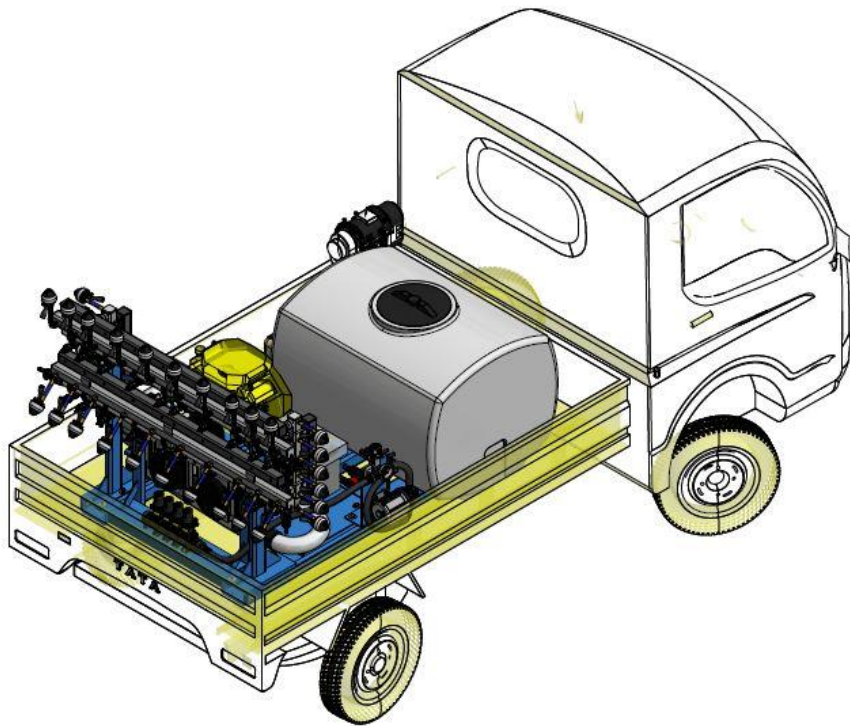

# Greenhouse Sprayers



SGC (Cart)



SGS (Skid)

# Greenhouse Sprayers



150SR

Metrolina Boom



80SR

# 8oSR

Single and Double Boom options for use in Greenhouses



# 80SR

adjustable double boom for vineyards, narrow, vertical or standard row crops



# 100SR



# 150SR



# 150SR

Boom Variations

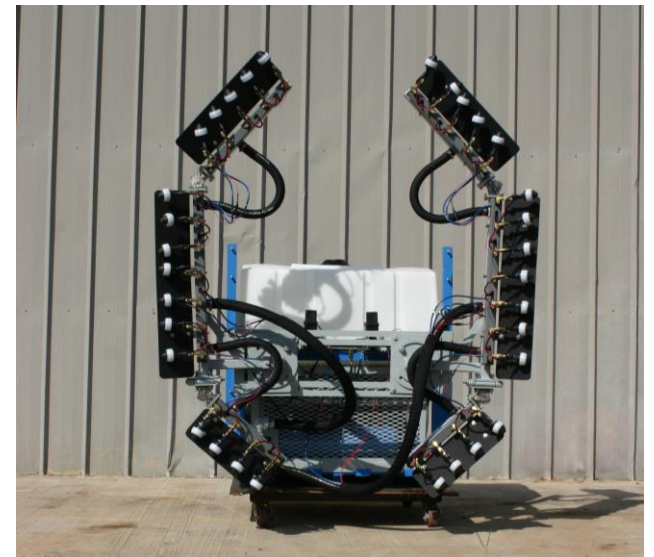
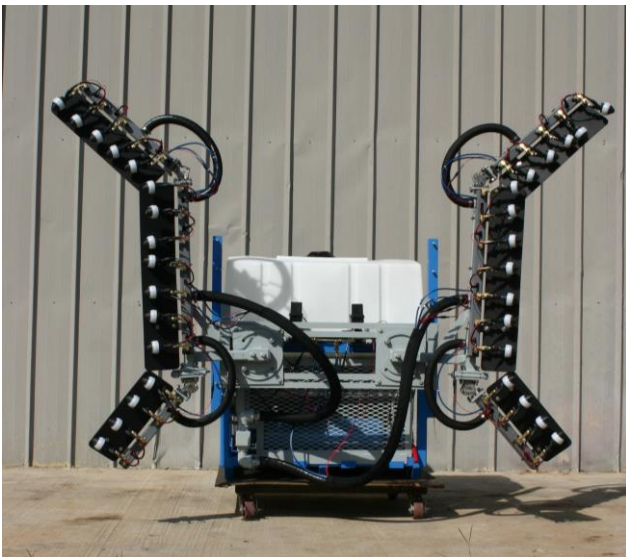
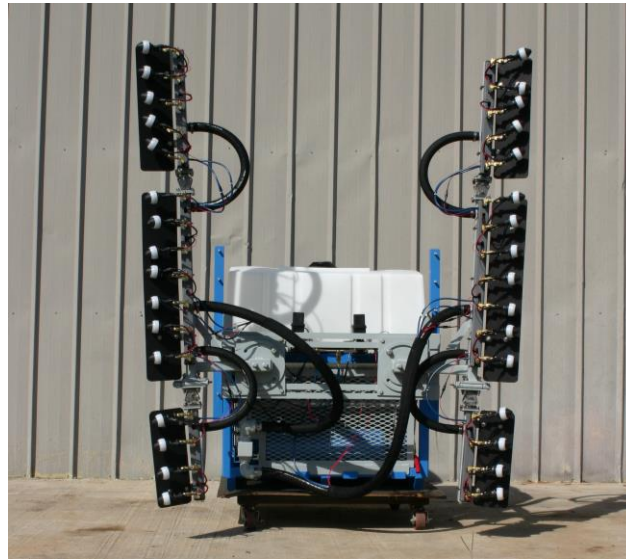
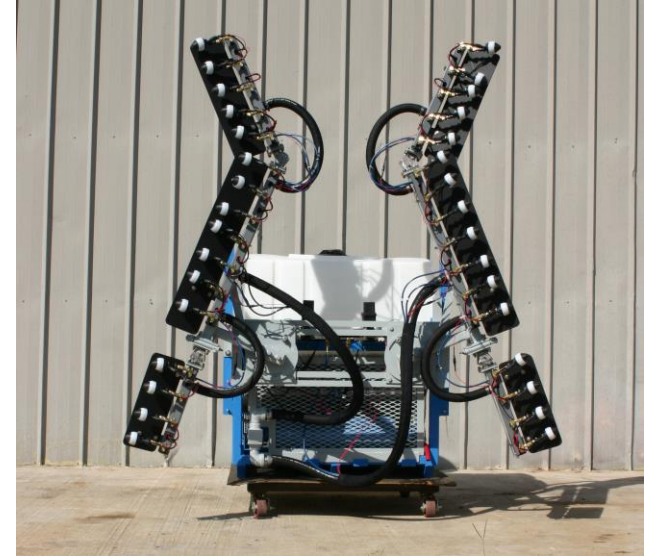



# 150 VT



# 150RB



# 150RB

Boom Variations

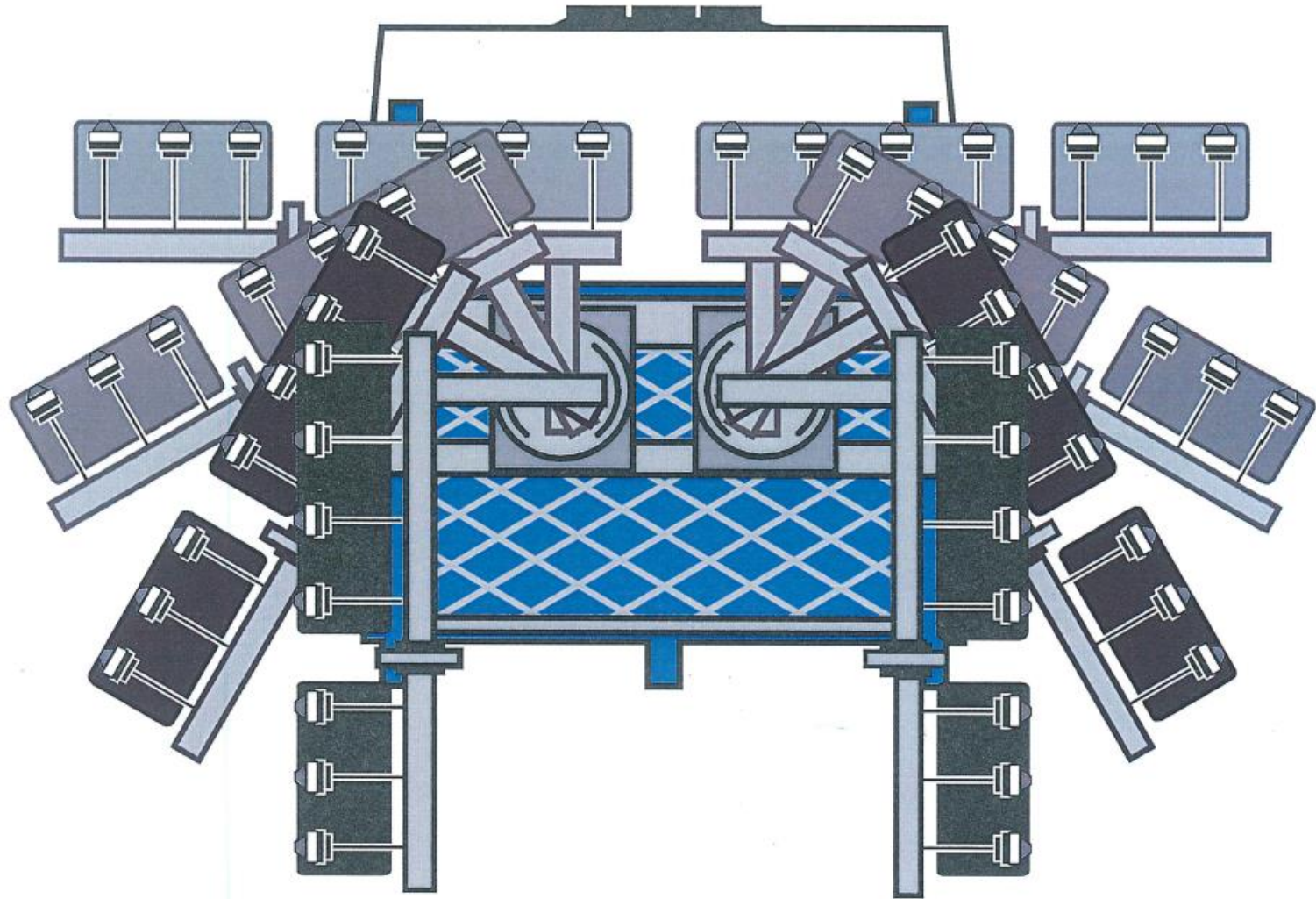

# 250EF28

Double Row – Ideal for Vineyards



# Specialty Sprayers



150SR Double Nozzle – Kiwi



150VT Kenya – Coffee

150SR California – Pollen



# Specialty Sprayers



150AV Mexico – Agave



350 South Africa – Apples

# 350RC



# 450RC





# 450RC



# Modified and Retrofitted Sprayers



Top Air



Retrofit John Deere – California

# Modified and Retrofitted Sprayers



# Food Safety Application



# Miscellaneous Sprayers



Conveyor Test Unit



Spray Tanning