

KR615 “UV BOX”

Germicidal Enclosure

User’s Manual



Table of Contents

Operating Information	Page 3
Location of Safety and Compliance Labels.....	Page 4
Warnings, Precautions, and Limitations for Use.....	Page 5
Safety Warnings and Precautions.....	Page 6
Voltage Warnings and Precautions.....	Page 9
Cleaning Precautions.....	Page 11
Indications for Use.....	Page 12
System User Safety Controls.....	Page 13
Procedures for Disposal of UVC Blubs.....	Page 14
Special Handling Information for Broken UVC Blubs.....	Page 14
Repair and Maintenance.....	Page 15
Bulb and Rod Replacement.....	Page 16
Trouble Shooting.....	Page 17
Cleaning the AUVS Germicidal Enclosure.....	Page 18
Specifications and Warranty Information.....	Page 20
Warranty Card.....	Page 21

Warnings and Precautions Symbols



The exclamation point, within a circle, is intended to alert the user to the presence of important operating and maintenance instructions in the literature accompanying the device.



The lightning flash with the arrowhead symbol, within an equilateral triangle, is intended to alert the user to the presence of uninsulated “dangerous voltage” within the device’s enclosure that may be of sufficient magnitude to constitute the risk of electrical shock.

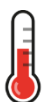

The thermometer is intended to alert the user to the presence of internal components that may reach high temperatures within the device’s enclosure that may be of sufficient temperature to cause a burn.

Operating Information



Place any item inside the UV Box without stacking or overlapping.



Close the door and turn the knob to lock for Disinfection Cycle.



Press the red button to begin the Disinfection Cycle.



When the cycle is complete, remove your disinfected item.

Operating Instructions

- 1) Clean visible dirt, moisture or liquid residue from items to be disinfected as per manufacturer's instructions.
- 2) Place item(s) in the AUVS Germicidal Enclosure (UV Box).
- 3) **IMPORTANT: Use caution when placing objects inside, and removing objects from the AUVS Germicidal Enclosure. The Quartz Rods will break if undue force is used.**
- 4) When disinfecting multiple items, do not stack or allow sides of items to touch.
- 5) Close the door and turn the knob. Press the red button to begin the decontamination cycle.
- 6) When the red button and LED indicators turn off, remove item(s) and use normally.

Note: Covered surfaces not contacted by the UV light will not be disinfected.

Location of Safety and Compliance Labels

Advanced Ultra-Violet Systems is in compliance with various regulations, details of which are listed in the Specifications section. The AUVS Germicidal Enclosure safety and compliance label, shown below, is located on the right panel of the AUVS Germicidal Enclosure.

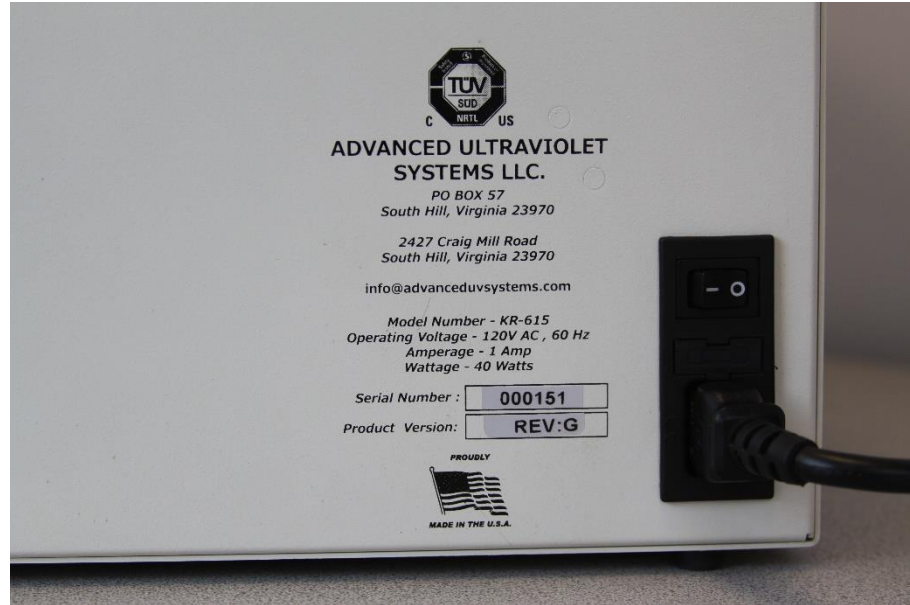

AUVS Germicidal Enclosure Safety and Compliance Label



Location of AUVS Germicidal Enclosure Safety and Compliance Label

Warnings, Precautions, and Limitations for Use

Post-Disinfection Warnings



WARNING: The AUVS Germicidal Enclosure is intended to disinfect mobile devices and non-critical medical devices. The subsequent utilization of the mobile devices and non-critical medical devices disinfected by the AUVS Germicidal Enclosure is the sole responsibility of the user.

Ultraviolet Light Bulb Warnings and Precautions



WARNING: Non-protected eyes or skin should never be exposed directly to UVC.



WARNING: Ultraviolet bulbs contain mercury, and therefore, must be properly disposed of as a hazardous waste in accordance with local, state, and federal regulations or the lamps should be recycled.



WARNING: Take precaution with broken UVC bulbs to avoid inhalation, ingestion, or contact with skin or eyes. See **Procedures for Disposal of Bulbs and Special Handling Information for Broken Bulbs**.

Safety Warnings and Precautions



Advanced Technology for Critical
Clean Air Needs

Re: UVC Light Effects on Small Electronic Devices

From: Dr. Wayne Clark., Ph.D. Electrical Engineering, Plasma Physics, and Nuclear Fusion Research

To whom it may concern:

I have been involved over the past 30 years in research and development of intense ultraviolet sources and using that UV energy for antimicrobial applications. The technology that is presently being used in the Germicidal Enclosure "UV Box" is the same technology that I developed for the United States Department of Defense as part of the "Immune Building Program" to protect against bioagent attacks. This technology was researched and developed through a DARPA grant and is currently installed in the HVAC of the United States Pentagon providing air sterilization. The UV Box small device uses the same technology-based on photon multiplication that uses a low energy UV to achieve the killing efficacy for C.difficile spores and other potentially deadly pathogens.

The question has been asked many times as to the effect of UV-C on electronic devices such as mobile phones, tablets, and other sensitive medical devices. To answer this, it is important to understand Ultra-violet light and the average intensity used for disinfection. The basic fact is that 254 nm UV light that is typically used for pathogen disinfection has a very short penetration depth into almost all materials. For example, the penetration depth into metals is essentially zero. On the other hand, the penetration depths for plastics and ordinary glass materials are less than a few thousandths of an inch or immeasurable. The only materials that transmit wavelengths near 254 nm even short distances are a couple of very special pure quartz or sapphire materials. These materials are used for the envelopes of the UV-Box's lamps. AUVS also uses a pure quartz material for the rods in the AUVS Germicidal Enclosure "UV Box" to eliminate obstruction of the UV-C light while supporting the objects that are being disinfected.

The electronics in phones and electronic devices are located inside metal, glass and plastic enclosures. So, as a result, the UV-C can't penetrate the enclosures of electronic devices to reach the electronics. The electronics are totally shielded from the UV-C light. In addition, even if the UV could reach the electronic circuits inside the device enclosure, the photon energy of 254 nm UV-C is too low to damage semiconductors, printed circuits, etc. UV-C light wouldn't cause damage to the electronic circuits even if it could reach them. But, again, the electronic circuits are shielded from the all UV light. Therefore, UV generated by the AUVS UV-Box and other similar devices cannot damage electronics placed within it.

Wayne

Dr. Wayne Clark, President, CEO
Novatron. Inc.
5080 Sea Mist Ct.
San Diego, CA. 92121
Tel: 858 775 5258
www.NovatronInc.com



WARNING: Do not bypass any of the safety precautions built into the device. Failure to comply may result in exposing skin to UVC. Prolonged skin exposure may generate redness and an uncomfortable sunburn sensation.



WARNING: The AUVS Germicidal Enclosure “UV Box” should not be operated by children.

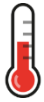

WARNING: High Temperature – UVC bulbs and assembly may develop high temperatures. The UVC bulb reflector heads can reach high temperatures during operation but cool quickly upon completion of disinfection cycle.



WARNING: All assembly, adjustment, modification, maintenance and/or repair of REV G Models should be performed by qualified personnel authorized by Advanced Ultra-Violet Systems (AUVS)



WARNING: Only AUVS approved replacement parts should be used with maintaining the device.



WARNING: Do not remove any warnings, cautions, or descriptive labeling from the AUVS Germicidal Enclosure.



PRECAUTION: The product must be used in accordance with this User’s Manuel.



PRECAUTION: Avoid spilling fluids on any part of the AUVS Germicidal Enclosure.



Do not place food, drink or medication inside of the AUVS Germicidal Enclosure. For additional info please see intended use under **Indications for Use.**



PRECAUTION: If spills do occur, immediately disconnect the AUVS Germicidal Enclosure from the power source and contact Technical Support (866-918-8546) for guidance on cleaning the AUVS Germicidal Enclosure.



PRECAUTION: Never attempt to disinfect any objects considered to be critical medical devices. See intended use under **Indications for Use**.









PRECAUTION: Do not use any attachments not recommended by Advanced Ultra-Violet Systems, Inc.

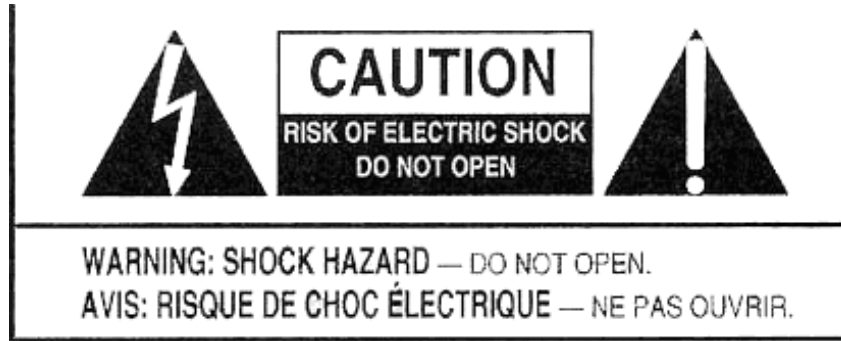

WARNING: Equipment is not to be used as a component of a life support system. Life support devices or systems are devices or systems that support or sustain life, and whose failure to perform can be reasonably expected to result in significant injury or death to a person. A critical component is any component of a life support device or system whose failure to perform can be reasonably expected to cause the failure of the life support device or system, or to affect its safety and effectiveness.

Voltage Warnings and Precautions



-  Older Models of the AUVS Germicidal Enclosure (REV G) have no user-serviceable parts inside. Servicing to be performed by factory-authorized personnel only. Removal of labels, covers, or encasement fasteners voids the warranty. For servicing newer models (REV H) of the AUVS Germicidal Enclosure, see **Bulb and Rod Replacement**.
-  **WARNING:** The power cord connected to the AUVS Germicidal Enclosure is the main disconnect for the system.
-  **PRECAUTION:** When positioning the AUVS Germicidal Enclosure ensure that the connection to the AC mains (wall outlet) is not obstructed, so that disconnection is not blocked in the case of emergency.
-  **WARNING:** Disconnect the power cord from the wall outlet before servicing to avoid the possibility of electric shock.
-  **WARNING:** The AUVS Germicidal Enclosure must be connected to a grounded electrical outlet to maintain grounding reliability.
-  **PRECAUTION:** The electrical installation of the room in which the AUVS Germicidal Enclosure will be operated must comply with the local electrical wiring standards.



PRECAUTION: Never operate the AUVS Germicidal Enclosure if it has a damaged power cord, power supply or plug. If the power cord, power supply or plug is worn or damaged, contact Safety Net, LLC at 866-918-8546.



WARNING: Any power extension cord used with the AUVS Germicidal Enclosure must include a safety ground, meet ratings for the device, and meet all pertinent regional and local safety codes.



WARNING: Explosion Hazard – Do not operate the AUVS Germicidal Enclosure in the presence of flammable vapors.



WARNING: To prevent fire or shock hazard, do not expose this device to rain or moisture. Do not submerge the AUVS Germicidal Enclosure in liquid of any kind. Do not spray liquids of any kind inside the AUVS Germicidal Enclosure. Do not put containers of liquid of any kind inside the AUVS Germicidal Enclosure.



WARNING: Always power off the system before cleaning. An electrical shock could occur if the system is powered on during cleaning.

Cleaning Precautions



PRECAUTION: Refer to **Cleaning the Enclosure** for recommended cleaning of the AUVS Germicidal Enclosure.



PRECAUTION: Apply cleaning agents to a clean, lint-free cloth **first** and then clean the device. Liquid sprayed or applied directly to the device could possibly leak inside and cause damage.



PRECAUTION: Allow the device to completely dry before operating again.



PRECAUTION: Never use abrasive materials.



PRECAUTION: Never use any disinfecting agents that corrode.



PRECAUTION: Always dilute cleaning agents according to manufacturer's instructions.



PRECAUTION: Do not allow the cleaning agent to remain on the device surface. Wipe off immediately with a lint-free cloth moistened with water. Failure to do so may result in discoloration of the surface.



WARNING: Advanced Ultra-Violet Systems makes no claims regarding the efficacy of the listed chemicals or methods as a means of controlling infection. Consult your facility's infection control officer or epidemiologist.

Indications for Use

Intended use

The AUVS Germicidal Enclosure disinfection unit is intended to allow authorized trained personnel the ability to disinfect a non-critical medical device (NCD), small personal items, or mobile devices such as Tablets, and Phones on demand. Only devices that make topical contact with intact skin are intended for AUVS disinfection. Devices suitable for AUVS Germicidal Enclosure application are non-critical devices used in a healthcare environment. The AUVS Germicidal Enclosure is not intended to be used to pre-clean or decontaminate critical or semi-critical medical devices prior to terminal sterilization or high-level disinfection.



WARNING: Do not place vessels containing liquid of any kind, or bottles containing medications of any kind, into the AUVS Germicidal Enclosure.

Device Indications for Use Statement

The AUVS Germicidal Enclosure’s disinfection function is achieved through the application of high-intensity germicidal UVC light applied at a known intensity and for a known duration. The intention is to allow the user to position their non-critical medical devices and small mobile devices inside the AUVS Germicidal Enclosure for disinfection process. Operation of the system is to take place outside of sterile fields and by personnel performing their duties outside of sterile fields. Typical operating personnel are trained professionals, including but not limited to physicians, nurses, technicians, and environmental services staff.

System User & Safety Controls

The AUVS Germicidal Enclosure has multiple safety controls and mechanisms to ensure that users are safe and protected during the UVC disinfection operations.



WARNING: Do not intentionally bypass any of the safety precautions built into the device. Failure to comply may result in exposing skin to UVC. Prolonged skin exposure may generate redness and an uncomfortable sunburn sensation.

The following safety controls are built into the AUVS Germicidal Enclosure:
The outer casing has an easily accessible power switch. The door in the front of the AUVS Germicidal Enclosure has a locking knob that when turned counter-clockwise to “Open” will immediately turn off the power to the UV light source. The door frame has a safety button that will not allow the AUVS Germicidal Enclosure to engage unless the door is properly secured. In addition, the AUVS Germicidal Enclosure can be unplugged to disconnect power and light source.



If your AUVS Germicidal Enclosure is equipped with the **Cycle Track** option, a counter on the left side of the unit keeps a continuous count each time the door is opened and closed, allowing you to track the unit’s utilization.



Procedures for Disposal of UVC Bulbs

AUVS technology uses bulbs with lower mercury content than typical overhead lighting, and cleaning should follow the practices required by your facility and in accord with applicable regulations. As a guideline, if bulbs are broken, ventilate the area where the breakage occurred. Clean up with mercury vacuum cleaner or other suitable means that avoid dust and mercury vapor generation. Take usual precautions for collection of broken glass. Clean up requires special care due to mercury droplet proliferation. Place materials in closed containers to avoid generating dust. It is the responsibility of the generator to ensure proper classification of waste products. To that end, TCLP tests should be conducted on all waste products to determine the ultimate disposition in accordance with all applicable federal, state and local regulations.

Special Handling Information for Broken UVC Bulbs

Ventilation: Use adequate general and local exhaust ventilation to maintain exposure levels below the permissible exposure limit (PEL) or threshold limit value (TLV) limits. If such ventilation is unavailable, use respirators as specified below.

Respiratory Protection: Use appropriate NIOSH (National Institute for Occupational Safety and Health) approved respirator if airborne dust concentrations exceed the PEL or TVL limits. All appropriate requirements set forth in 29 CFR 1910134 should be met.

Eye Protection: OSHA (Occupational Safety and Health Administration) specified safety glasses, goggles or face shield are recommended if bulbs are broken.

Hygienic Practices: After handling broken bulbs, wash thoroughly before eating, smoking or using the toilet facilities.

In the event that a UV Box bulb arrives in a broken condition and is still inside the bag, keep the bag sealed and discard the UV Box bulb in accord with the practices required by your facility and with applicable regulations. Contact your carrier for procedures to file a damaged goods claim.

Check your local or regional specific occupational safety standards for any additional procedures or precautions required for the handling of broken UVC bulbs.

Repair and Maintenance

Testing



UV Intensity Labels should be used to periodically test the effectiveness of the bulbs in your AUVS Germicidal Enclosure. These labels can be purchased from your local AUVS Sales Representative, or from Safety Net, LLC (866-918-8546). Please contact Safety Net, LLC for pricing and details.

Item # UVIL-110 – 110 per sheet.

Item # UVIL-55 – 55 per sheet.

Replacement Parts

The Following Replacement parts for the AUVS Germicidal Enclosure can be ordered/purchased from Safety Net, LLC (866-918-8546) for REV H Model Units. Please contact Safety Net, LLC for pricing and details.

Item # AUVS-QR - Quartz Rod, single

Item # AUVS-UVL2 - UV Lamps, set of two

Item # AUVS-GAS – Door Gasket (factory repair only)



Note: UV Box models that do not have a side access panel (REV G) must be returned to the factory for repair or replacement.

Bulb and Rod Replacement



Note: Use of any bulb other than that expressly and directly purchased from an Advanced Ultra-Violet Systems fully authorized source will cause failure in the disinfection cycle. This may result in electrical failure that is not covered under warranty and will cause premature device failure. Use of any bulbs other than those provided by the manufacturer is prohibited. In order to replace a bulb or a quartz rod, follow these instructions:



Note: UV Box Models that do not have a side access panel (REV G) must be returned to the factory for repair or replacement.

Replacing a Quartz Rod

- First, remove the access panel on the left side of the UV Box. (see figure A)
- Carefully slide out the broken Quartz Rod. Be cautious of sharp edges.
- Discard broken rod, making certain to remove all fragments from the inside of the AUVS Germicidal Enclosure. See: **Cleaning the AUVS Germicidal Enclosure.**
- Gently insert the new Quartz Rod in the vacant slot and replace the access panel.

Replacing UVC Bulbs

- First, remove the access panel on the left side of the UV Box. (see figure A)
- Carefully slide out and set aside the Quartz Rods to gain access to the UVC Bulb enclosure. Remove UVC Bulbs. See: **Procedures for Disposal of Bulbs and Special Handling Information for Broken Bulbs.**
- Replace inoperative UVC bulbs with new AUVS Approved UVC Bulbs only. **Please note: For maximum efficiency, it is recommended that you replace both UVC bulbs, even if one is still operative.**
- Gently reinsert the Quartz Rods into their slots and replace the access panel.

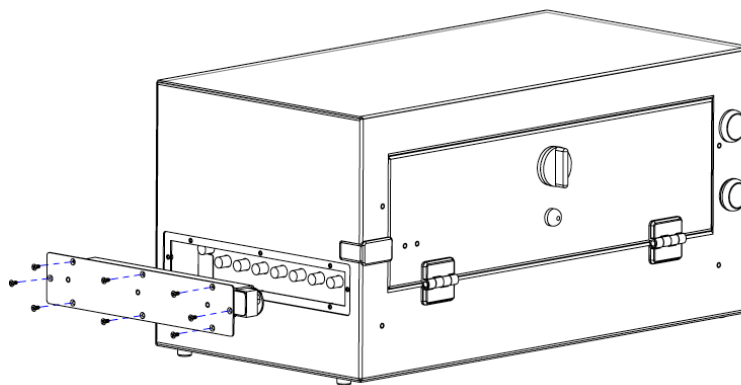

Figure A

Trouble Shooting



If objects become stuck between the Quartz Rods or fall beneath the Quartz Rods, DO NOT forcibly remove them. This can result in cracking or breaking of the Quartz Rods. If objects cannot be gently extracted, see page 16 for instructions on removing Quartz Rods to release, or gain access to an object that has become stuck.

TROUBLE	POSSIBLE CAUSE	POSSIBLE REMEDY
Device will not engage when door is secured and start button is pushed.	Door Handle is loose and not shutting tightly enough to engage safety button.	Test: Close door and push and hold top right corner of door as you push the start button. If device engages, door handle needs to be adjusted. See instructions below.
Device will not engage when door is secured and start button is pushed.	Broken or burned out UV Bulb	Device will not engage if one bulb is burned out or broken. See Page 16 for instructions on replacing broken or burned out UV bulbs.



To Adjust Door Handle, use ½” Wrench.



Adjust the hex nut closest to the door first, tightening the hex nut so that the door latch moves closer to the door. Next, tighten the top hex nut until the latch mechanism is snug between the two hex nuts. Retest the UV Disinfection Device by closing door to see if the start button will engage. Repeat as necessary until the door latch is in the proper position to engage the safety button.

Cleaning the AUVS Germicidal Enclosure



PRECAUTION: Avoid spilling fluids on any part of the AUVS Germicidal Enclosure.



PRECAUTION: If spills do occur, immediately disconnect the AUVS Germicidal Enclosure from the power source and contact Safety Net, LLC for guidance in cleaning the device at: 866-918-8546.



WARNING: Always power off the system before cleaning. An electrical shock could occur if the device is powered on and liquid is spilled into it.

To clean the **OUTSIDE** of the AUVS Germicidal Enclosure without physical or cosmetic degradation, use a clean, lint-free cloth moistened with one of the following:

- Phenolic Disinfectant Cleaner (meets VII.d.4 of AORN recommendation)
- 1 part household bleach and 5 parts water (meets VII.e.2 of AORN recommendation)
- A-456-N Disinfectant
- Virex 256 Disinfectant
- Isopropyl Alcohol, 70% solution

The following pre-moistened disposable cloths may also be used for cleaning the **OUTSIDE** of the Device.

- PDI Sani-Cloth HB
- PDI Sani-Cloth PLUS
- PDI Super Sani-Cloth

To clean the **INSIDE** of the AUVS Germicidal Enclosure without physical degradation, use only a clean lint-free cloth moistened with a mixture of alcohol and water (1:1). Residues of alcohol-based cleaning products should be wiped away with a clean lint-free cloth moistened with water. Allow the device to dry completely before operating again.

Cleaning Precautions



PRECAUTION: Apply cleaning agents to clean lint-free cloth first and then clean the device. Liquid sprayed or applied directly to the device could possibly leak inside and cause damage.



PRECAUTION: Allow the device to completely dry before operating again.



PRECAUTION: Never use abrasive materials.



PRECAUTION: Never use any disinfecting agents that corrode.



PRECAUTION: Always dilute cleaning agents according to manufacturer's instructions.



PRECAUTION: Do not allow the cleaning agent to remain on the device surface. Wipe off immediately with a lint-free cloth moistened with water. Failure to do so may result in discoloration of the surface.



WARNING: Advanced Ultra-Violet Systems makes no claims regarding the efficacy of the listed chemicals or methods as a means of controlling infection. Consult your facility's infection control officer or epidemiologist.

Specifications and Warranty Information

AUVS Germicidal Enclosure Specifications	
Overall Dimensions	10" H x 10" D x 20" W
Enclosure Dimensions	3.5" H x 8" D x 15.5" W
Weight	10 lbs.
Power	110V, AC
Bulb Life	16,000 hours = 50+ years under normal use.

The KR615 UV Germicidal Enclosure Device is warranted for two (2) years from the date of purchase. All parts and labor are covered under this period, excluding damage due to abuse by the user.

*By registering your UV Germicidal Enclosure you can extend the warranty on your **UVC Bulbs Only** an additional five (5) years.

***To be considered valid, Warranty Registrations must be received within 30 days of purchase.**

You can register this warranty one of two ways. By filling out the attached Warranty Registration and emailing it to: info@safetynetamerica.com Or by visiting the Safety Net Website: www.safetynetamerica.com and filling out the online form.

Warranty Repairs

Please contact Safety Net, LLC (866-918-8546, info@safetynetamerica.com) for details on how to return/repair a defective unit that is under warranty. Please do not return your UV Germicidal Enclosure without first contacting Safety Net, LLC for an RMA and special packaging instructions. Damage due to improper packing will not be covered under your warranty. The same process applies to units that are no longer under warranty.



AUVS Germicidal Enclosure Warranty Form

Send this copy to: info@safetynetamerica.com, or fill out online at www.safetynetamerica.com

Facility Name: _____

Contact Name: _____

Contact Phone Number: _____

Facility Address: _____

UV Box Date of Purchase: _____

UV Box Purchased From: _____

UV Box Serial Number: _____

The KR615 UV Germicidal Enclosure Device is warranted for two (2) years from the date of purchase. All parts and labor are covered under this period, excluding damage due to abuse by the user. Shipping and handling not included.

*This Warranty Registration extends the warranty on the **UVC Bulbs ONLY** to seven (7) years total from date of purchase.



Questions? Please call 866-918-8546

* Warranty Registration must be received within 30 days of product delivery to be valid.

AUVS

ADVANCED ULTRA-VIOLET SYSTEMS
Germicidal UV Enclosures for Healthcare

For Sales and Service, Please contact Safety Net, LLC

www.safetynetamerica.com

info@safetynetamerica.com

866-918-8546

Safety Net
Solutions that save lives.

